

# R-GAGE Q120RA-AF

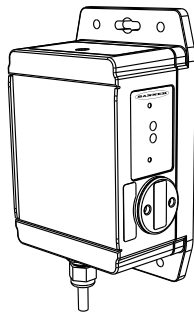

Radar-Based Narrow-Beam Sensors for Detection of Moving and Stationary Targets



## Features

- Fourth generation FMCW (true-presence) radar detects moving and stationary objects
- Narrow beam pattern and high sensitivity
- Adjustable sensing field — ignores objects beyond setpoint
- Easy setup and configuration of range, sensitivity, and output with simple DIP switches
- Sensing functions are unaffected by wind, falling rain or snow, fog, humidity, air temperatures, or light
- Sensor operates in Industrial, Scientific, and Medical (ISM) telecommunication band; no special license required
- Rugged IP67 housing withstands harsh environments

Protected by US patents

## Models

Model <sup>1</sup>	Sensing Range	Connection	Supply Voltage	Telecom Approval	Output
Q120RA-US-AF	12 m (39.4 ft)	5-wire 2 m (6.5 ft) Integral cable	12 to 30V dc	Telecom approved for US	Bipolar NPN/PNP DIP-switch-selectable N.O. or N.C.
Q120RA-EU-AF				Telecom approved for Europe (except UK), Australia, and New Zealand	
Q120RA-UK-AF				Telecom approved for UK	



### CAUTION: Make No Modifications to this Product

Any modifications to this product not expressly approved by Banner Engineering could void the user's authority to operate the product. **Contact Banner Engineering for more information.**



### WARNING: Not To Be Used for Personnel Protection

**Never use this device as a sensing device for personnel protection. Doing so could lead to serious injury or death.** This device does not include the self-checking redundant circuitry necessary to allow its use in personnel safety applications. A sensor failure or malfunction can cause either an energized or de-energized sensor output condition.

<sup>1</sup> Cabled models only are listed. For integral 5-pin Euro-style (M12) quick-disconnect fitting, add suffix "Q" to the model number (for example, Q120RA-xx-AFQ). QD models require a mating cordset; see [Quick Disconnect \(QD\) Cordsets](#) on page 7.

## Overview

The R-GAGE sensor emits a well-defined beam of high-frequency radio waves from an internal antenna. Some of this emitted energy is reflected back to the receiving antenna. Signal processing electronics determine the distance from the sensor to the object based on the time delay of the return signal. The sensor can be configured (via DIP switches) to sense objects up to a specific distance, ignoring objects beyond this distance (also called background suppression).

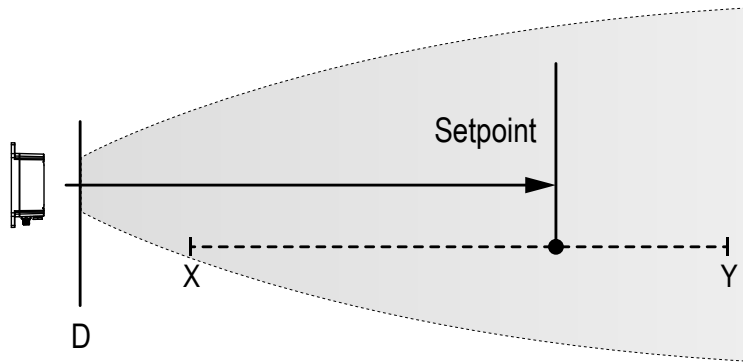

Figure 2. R-GAGE setpoint distances

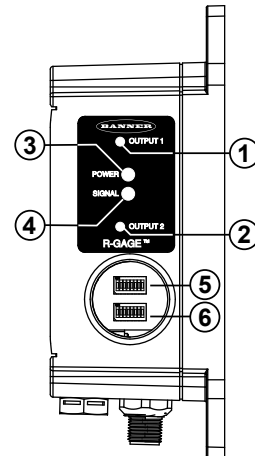

Figure 1. R-GAGE features

1. Output LEDs: Yellow (output 1 energized); Red (configuration)
2. Output LEDs: Yellow (output 2 energized); Red (configuration)
3. Power LED: Green (power ON)
4. Signal Strength LED: Red (flashes in proportion to the signal strength)
5. DIP switch row A
6. DIP switch row B

Access the DIP switches behind the threaded cap on the sensor side

		EU Model	US, UK Models
X	Minimum Zone 1 setpoint distance	2 m (6.6 ft)	3 m (9.8 ft)
Y	Maximum Zone 1 setpoint distance	12 m (39.4 ft)	12 m (39.4 ft)
D	Dead Zone <sup>2</sup>		

## Sensor Configuration

The sensitivity, and output configuration can be selected via the DIP switches on the side of the sensor.

Use the included spanner to open the screw-off cover on the side of the sensor and access the DIP switches.



**Important:** Tighten the DIP switch cover a full quarter turn after contact to maintain the watertight seal.

## DIP Switch Functions

Switches	Function
A1, A2, A3, A4	Sensing Distance (detects objects from sensor face to this point)
A5, A6, A7, A8	Not Used

<sup>2</sup> Typical dead zone: 0.4 m (1.3 ft) for moving and 1.0 m (3.3 ft) for stationary targets, but varies with target reflectivity.

Switches	Function
B1, B2, B3	Sensitivity (higher sensitivity sees weaker objects and has a larger beam pattern)
B4, B5, B6	Response Speed
B7	Normally Open/Normally Closed output functionality
B8	Not Used

DIP switch 1 is on the left and DIP switch 8 is on the right.

## Distance Settings

\* Default settings

Zone 1 Distance					
A1	A2	A3	A4	Distance	
				EU	US, UK
0	0	0	0	2 m (6.6 ft)	3 m (9.8 ft)
0	0	0	1	2.25 m (7.4 ft)	3 m (9.8 ft)
0	0	1	0	2.5 m (8.2 ft)	3 m (9.8 ft)
0	0	1	1	2.75 m (9.0 ft)	3 m (9.8 ft)
0	1	0	0	3 m (9.8 ft)	3.25 m (10.7 ft)
0	1	0	1	3.25 m (10.7 ft)	3.5 m (11.5 ft)
0	1	1	0	3.5 m (11.5 ft)	3.75 m (12.3 ft)
0	1	1	1	4 m (13.1 ft)	4 m (13.1 ft)
1*	0*	0*	0*	5 m (16.4 ft)	5 m (16.4 ft)
1	0	0	1	6 m (19.7 ft)	6 m (19.7 ft)
1	0	1	0	7 m (23.0 ft)	7 m (23.0 ft)
1	0	1	1	8 m (26.2 ft)	8 m (26.2 ft)
1	1	0	0	9 m (29.5 ft)	9 m (29.5 ft)
1	1	0	1	10 m (32.8 ft)	10 m (32.8 ft)
1	1	1	0	11 m (36.1 ft)	11 m (36.1 ft)
1	1	1	1	12 m (39.4 ft)	12 m (39.4 ft)

## Sensitivity Selection

\* Default settings

B1	B2	B3	Sensitivity
0*	0*	0*	8 (Highest)
0	0	1	7...
0	1	0	6 (High)
0	1	1	5...
1	0	0	4 (Medium)

B1	B2	B3	Sensitivity
1	0	1	3...
1	1	0	2 (Low)
1	1	1	1 (Lowest)

## Output Configuration

\* Default settings

B7	Normally Open / Closed
0*	N.O.
1	N.C.

## Response Speed

\* Default settings

B4	B5	B6	ON (ms)	OFF (ms)	Total (ms)
0	0	0	15	15	30
0	0	1	30	70	100
0	1	0	30	120	150
0*	1*	1*	50	300	350
1	0	0	50	600	650
1	0	1	30	1000	1030
1	1	0	120	600	720
1	1	1	120	6000	6120

## Specifications

### Range

The sensor is able to detect a proper object (see Detectable Objects) from 1 to 12 m (3.3 to 39.4 ft), depending on target

### Detectable Objects

Objects containing metal, water, or similar high-dielectric materials

### Operating Principle

Frequency modulated continuous-wave (FMCW) radar

### Operating Frequency

24.00 to 24.25 GHz, ISM Band (varies slightly with model, depending on national telecom regulations)

### Supply Voltage

12 to 30V dc, less than 100 mA, exclusive of load

### Supply Protection Circuitry

Protected against reverse polarity and transient over-voltages

### Delay at Power-up

Less than 2 seconds

### Indicators

**Power LED:** Green (power ON)

**Signal Strength LED:** Red, flashes in proportion to signal strength. Steady on at 4x excess gain. Only indicates signal amplitude, not target distance.

**Output LEDs:** Yellow (output energized) / Red (configuration)

See [Figure 1. R-GAGE features](#) on page 2

### Adjustments

DIP-switch-configurable sensing distance, sensitivity, response time, and output configuration

### Construction

**Housing:** ABS/polycarbonate

**Lightpipes:** Acrylic

**Access Cap:** Polyester

### Operating Temperature

-40° to +65° C (-40° to +149° F)

### Environmental Rating

IP67

### Output Configuration

Bipolar NPN/PNP output, 150mA; DIP switch B7 selects N.O. (default) or N.C. operation

### Output Protection

Protected against short circuit conditions

### Response Time

DIP switches B4, B5, and B6 select ON/OFF response time

### Connections

Integral 5-wire 2 m (6.5 ft) cable or M12 Euro-style QD fitting. QD models require a mating cordset

### Certifications

ETSI/EN 300 440; FCC part 15; for others, contact Banner Engineering

FCC ID: UE3Q120RAUS—This device complies with Part 15 of the FCC Rules. Operation is subject to the following two conditions: (1) this device may not cause harmful interference, and (2) this device must accept any interference received, including interference that may cause undesired operation.

## Windows

The R-GAGE sensor can be placed behind a glass or a plastic window, but the configuration must be tested and the distance from the sensor to the window must be determined and controlled prior to installation. There is typically a 20% signal reduction when the sensor is placed behind a window.

Polycarbonate at 4 mm thickness performs well in most situations, but the performance depends on filler materials. Thinner (1 to 3 mm) windows have high reflection. The amount of reflection depends on the material, thickness, and distance from the sensor to the window.

Locate the sensor in a position of minimum reflection from the window, which will repeat every 6.1 mm of distance between the sensor and the window. The positions of maximum reflection from the window repeat between the minimums, and decrease in effect until the window is approximately 150 mm (5.9 in) away. Consult the factory for pre-tested window materials which can be used at any distance without issue.

Additionally, the face of the window should be protected from flowing water and ice by use of a flow diverter or hood directly above the window. Falling rain or snow in the air in front of the window, light water mist, or small beads on the face of the window are typically not an issue. However, a thick, continuous surface of water or ice directly on the face of the window can be detected as a dielectric boundary.

# Beam Patterns

Typical Beam Pattern (with BRTR-CC20E Radar Target, Radar Cross Section = 50 m<sup>2</sup>)

Left-Right Beam Pattern

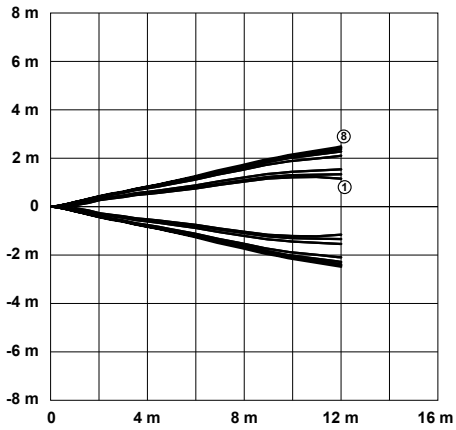

Up-Down Beam Pattern

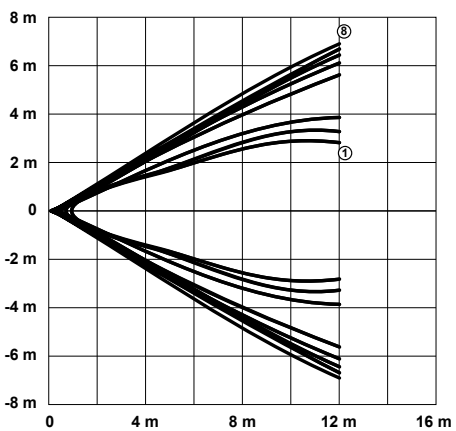

Distance

1–8: Indicates sensitivity level

Typical Beam Pattern (with 4 different targets) at highest sensitivity level

Left-Right Beam Pattern

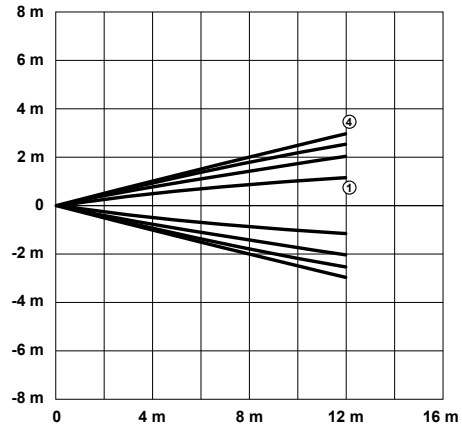

Up-Down Beam Pattern

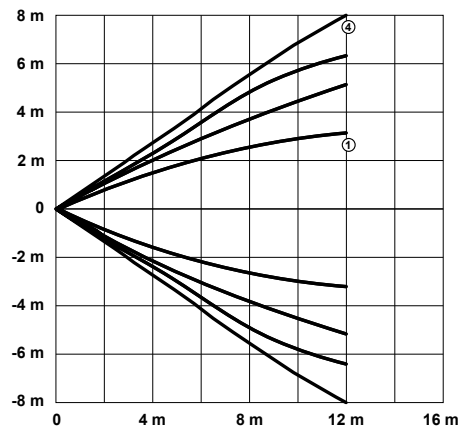

Distance

- 1: Weak Object (Radar cross section = 0.25 m<sup>2</sup>)
- 2: Car (Radar cross section = 3 m<sup>2</sup>)
- 3: Large Truck (Radar cross section = 50 m<sup>2</sup>)
- 4: Passenger Train (Radar cross section = 300 m<sup>2</sup>)



**NOTE:** The effective beam pattern depends on the sensitivity level and target properties.

## Dimensions

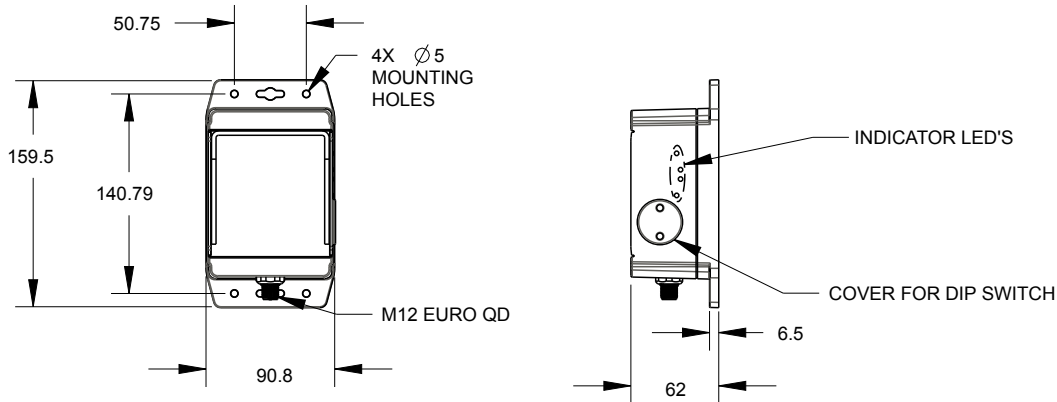

## Hookup

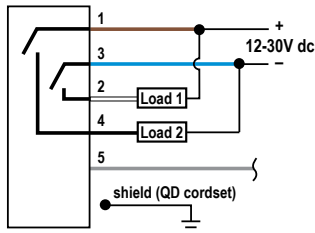

### Wiring Key:

- 1 = Brown
- 2 = White
- 3 = Blue
- 4 = Black
- 5 = Gray (Do not connect)



**NOTE:** Banner recommends that the shield wire (QD cordsets only) be connected to earth ground or dc common. Shielded cordsets are recommended for all QD models.

## Quick Disconnect (QD) Cordsets

5-Pin Threaded M12/Euro-Style Cordsets with Shield				
Model	Length	Style	Dimensions	Pinout
MQDEC2-506	1.83 m (6 ft)	Straight		<p>1 = Brown 2 = White 3 = Blue 4 = Black 5 = Gray</p>
MQDEC2-515	4.57 m (15 ft)			
MQDEC2-530	9.14 m (30 ft)			
MQDEC2-550	15.2 m (50 ft)			
MQDEC2-506RA	1.83 m (6 ft)	Right-Angle		
MQDEC2-515RA	4.57 m (15 ft)			
MQDEC2-530RA	9.14 m (30 ft)			
MQDEC2-550RA	15.2 m (50 ft)			



**NOTE:** Pin 5 is not used.

## Accessories

### SMBWSQ120

- Rear-Mount Protective Metal Enclosure
- Supports both horizontal and vertical sensor mounting
- Required if the R-GAGE is exposed to rain or snow
- Prevents buildup of water or ice from interfering with sensor performance

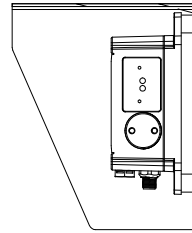

## Banner Engineering Corp Limited Warranty

Banner Engineering Corp. warrants its products to be free from defects in material and workmanship for one year following the date of shipment. Banner Engineering Corp. will repair or replace, free of charge, any product of its manufacture which, at the time it is returned to the factory, is found to have been defective during the warranty period. This warranty does not cover damage or liability for misuse, abuse, or the improper application or installation of the Banner product.

**THIS LIMITED WARRANTY IS EXCLUSIVE AND IN LIEU OF ALL OTHER WARRANTIES WHETHER EXPRESS OR IMPLIED (INCLUDING, WITHOUT LIMITATION, ANY WARRANTY OF MERCHANTABILITY OR FITNESS FOR A PARTICULAR PURPOSE), AND WHETHER ARISING UNDER COURSE OF PERFORMANCE, COURSE OF DEALING OR TRADE USAGE.**

This Warranty is exclusive and limited to repair or, at the discretion of Banner Engineering Corp., replacement. **IN NO EVENT SHALL BANNER ENGINEERING CORP. BE LIABLE TO BUYER OR ANY OTHER PERSON OR ENTITY FOR ANY EXTRA COSTS, EXPENSES, LOSSES, LOSS OF PROFITS, OR ANY INCIDENTAL, CONSEQUENTIAL OR SPECIAL DAMAGES RESULTING FROM ANY PRODUCT DEFECT OR FROM THE USE OR INABILITY TO USE THE PRODUCT, WHETHER ARISING IN CONTRACT OR WARRANTY, STATUTE, TORT, STRICT LIABILITY, NEGLIGENCE, OR OTHERWISE.**

Banner Engineering Corp. reserves the right to change, modify or improve the design of the product without assuming any obligations or liabilities relating to any product previously manufactured by Banner Engineering Corp.